

User Guide



10.1" Portable DVD Player

NS-P10DVD

Insignia NS-P10DVD 10.1" Portable DVD Player

Contents

Welcome	2
Important safety instructions	3
Features	4
Setting up your player.....	10
Using your player	16
Maintaining.....	34
Troubleshooting	35
Specifications	36
Legal notices.....	37
One-year limited warranty.....	39

Welcome

Congratulations on your purchase of a high-quality Insignia product. Your NS-P10DVD represents the state of the art in portable DVD player design and is designed for reliable and trouble-free performance.

Important safety instructions



The lightning flash with arrowhead symbol within a triangle is intended to alert you to the presence of uninsulated dangerous voltage within your player's enclosure that may be of sufficient magnitude to constitute risk of electric shock to persons.



The exclamation point within a triangle is intended to alert you to the presence of important operating and maintenance (servicing) instructions in the literature accompanying your player.

- 1 Read these instructions.
- 2 Keep these instructions.
- 3 Heed all warnings.
- 4 Follow all instructions.
- 5 Do not use this apparatus near water.
- 6 Clean only with dry cloth.
- 7 Do not block any ventilation openings. Install in accordance with the manufacturer's instructions.
- 8 Do not install near any heat sources such as radiators, heat registers, stoves, or other apparatus (including amplifiers) that produce heat.
- 9 Do not defeat the safety purpose of the polarized or grounding-type plug. A polarized plug has two blades with one wider than the other. A grounding type plug has two blades and a third grounding prong. The wide blade or the third prong are provided for your safety. If the provided plug does not fit into your outlet, consult an electrician for replacement of the obsolete outlet.
- 10 Protect the power cord from being walked on or pinched particularly at plugs, convenience receptacles, and the point where they exit from the apparatus.
- 11 Only use attachments/accessories specified by the manufacturer.
- 12 Use only with the cart, stand, tripod, bracket, or table specified by the manufacturer, or sold with the apparatus. When a cart is used, use caution when moving the cart/apparatus combination to avoid injury from tip-over.
- 13 Unplug this apparatus during lightning storms or when unused for long periods of time.



- 14 Refer all servicing to qualified service personnel. Servicing is required when the apparatus has been damaged in any way, such as power-supply cord or plug is damaged, liquid has been spilled or objects have fallen into the apparatus, the apparatus has been exposed to rain or moisture, does not operate normally, or has been dropped.
- 15 To reduce the risk of fire or electric shock, do not expose this device to rain, moisture, dripping, or splashing, and no objects filled with liquids, such as vases, shall be placed on it.
- 16 An apparatus with a three-prong, grounding-type plug is a Class I apparatus, which needs to be grounded to prevent possible electric shock. Make sure that you connect this Class I device to a grounding-type, three-prong outlet.
- 17 The wall plug is the disconnecting device. The plug must remain readily operable.
- 18 Batteries should not be exposed to excessive heat such as sunshine, fire, or the like.

Caution

Danger of explosion if battery is incorrectly replaced. Replace only with the same or equivalent type.

Features

Large content display—Includes a 10.1" TFT wide-screen LED display for a cinematic video experience.

High resolution panel—Adopts MPEG-2 encoding format and brings the horizontal resolution to over 500 lines.

Compatibility—Plays DVDs and CDs.

Parental lock—Makes it easy to control what discs can be played based on ratings.

Convenient multi-function remote — Provides useful functions, such as fast forward, fast reverse, slow play, and repeat play at the touch of the fingertip.

Zoom function—Enlarge pictures 2x, 3x, or 4x, or shrink to 1/2, 1/3, or 1/4 of the original size.

Time search—Locates a specific section of a disc. This feature is especially good for watching action movies.

Multi-language on-screen display (OSD)—Lets you select English, French, or Spanish for use in OSD menus.

Audio output—Provides analog audio output and coaxial digital audio output connections so you can connect your player to an amplifier for high quality sound.

Portability—Lets you take your player with you using rechargeable batteries and headphone output.

Note

Your player's DVD region code is 1. You can play any DVD with a region code of 1 or ALL. The DVD region code is listed on the DVD label or packaging.

Front

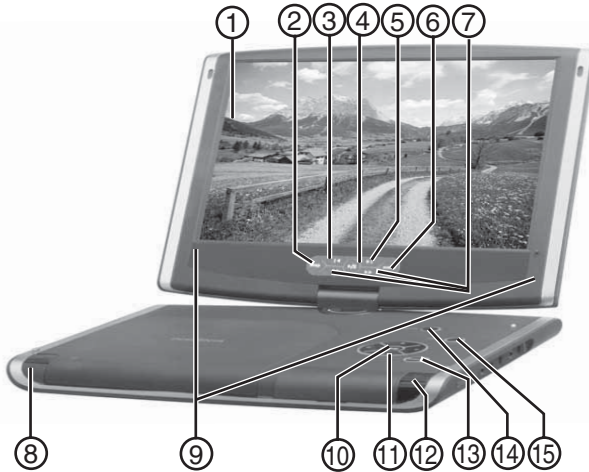

No.	Component	Description
1	TFT LED	Displays the DVD image and on-screen display (OSD).
2	STOP button	Press to stop disc playback.
3	PREV button	Press to go to the previous DVD chapter or CD track.
4	PLAY/PAUSE button	Press to start or pause disc playback.
5	NEXT button	Press to go to the next DVD chapter or CD track.
6	SCREEN button	Press once to access the brightness controls. Press twice to access the contrast controls. Press three times to access the color level controls. Press four times to access the aspect ratio controls.
7	◀◀ ▶▶	Press to search backward or forward on a disc.
8	OPEN button	Press to open the disc tray.
9	Speakers	Provide audio output when the headphones are not plugged in.

No.	Component	Description
10	OK button	Press to confirm selections in the on-screen display (OSD).
11	Direction buttons	Press to select options in the on-screen display (OSD).
12	POWER button	Press to turn your player on and off.
13	MENU button	Press to open the DVD menu.
14	SOURCE button	Press to select the video input source.
15	SETUP button	Press to open the Setup menu.

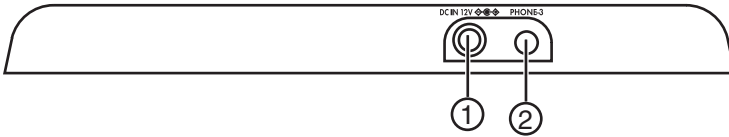
Left

No.	Component	Description
1	DC IN	Plug the AC adapter into this jack.
2	PHONE 3	Plug a second set of headphones into this jack.

Right

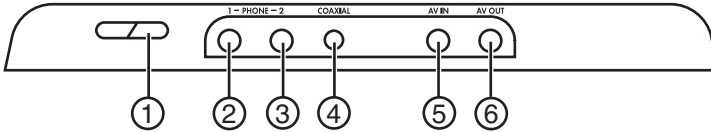

No.	Component	Description
1	VOLUME buttons	Press + or – to increase or decrease the volume.
2	PHONE 1	Plug a set of headphones into this jack.
3	PHONE 2	Plug a set of headphones into this jack.
4	COAXIAL OUT	Plug a digital coaxial cable into this jack and into the coaxial IN jack on an amplifier.
5	AV IN	Plug the mini connector on the AV cable into this jack. Plug the other connectors into the audio/video jacks on an external audio/video device to show the picture from the external device.
6	AV OUT	Plug the mini AV connector on the AV cable into this jack. Plug the other connectors into an external audio/video device.

Remote control

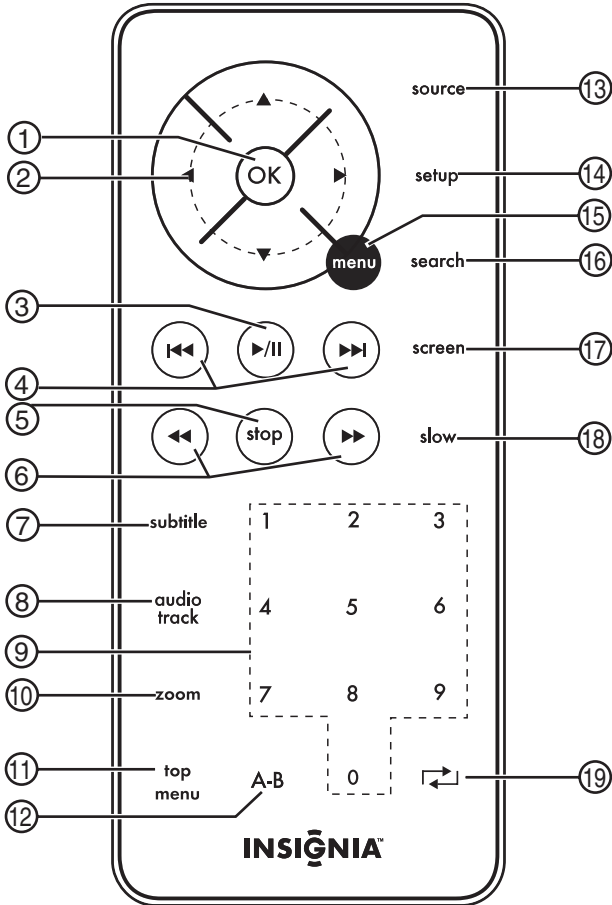

No.	Button	Description
1	OK	Press to confirm selections in the OSD.
2	▶ ◀ ▲ ▼ (Direction buttons)	Press to make selections in the OSD.
3	▶ / (Play/Pause)	Press to start or pause disc playback.
4	▶▶▶▶ (Next) ◀◀◀◀ (Previous)	Press to go to the next or previous DVD chapter or CD track.
5	STOP	Press to stop disc playback.
6	◀◀◀ (Fast-reverse) ▶▶▶ (Fast-forward)	Press to fast-forward or fast-reverse on a DVD or CD.

No.	Button	Description
7	SUBTITLE	Press to turn DVD subtitles on or off.
8	AUDIO TRACK	Press to select the DVD audio language if the DVD has multiple audio languages.
9	Number buttons	Press to select DVD chapters and titles or CD tracks. In the OSD, press to enter your password.
10	ZOOM	Press to change the image size.
11	TOP MENU	When a DVD menu is open, press to return to the title menu.
12	A-B	Press to create a playback loop.
13	SOURCE	Press to select the video input source.
14	SETUP	Press to open the SETUP menu.
15	MENU	Press to open the DVD menu.
16	SEARCH	Press to search on a DVD or CD.
17	SCREEN	Press once to access the brightness controls. Press twice to access the contrast controls. Press three times to access the color level controls. Press four times to access the aspect ratio controls.
18	SLOW	Press to play a DVD in slow-motion.
19	 (Repeat)	Press to repeat a DVD chapter, CD track, or an entire disc.

Setting up your player

Package contents

Make sure the package contains the following items:

- DVD player
- A/V cable
- Remote control with battery installed
- User guide
- AC power adapter
- Rechargeable battery back
- Car cigarette lighter adapter

Using the remote control

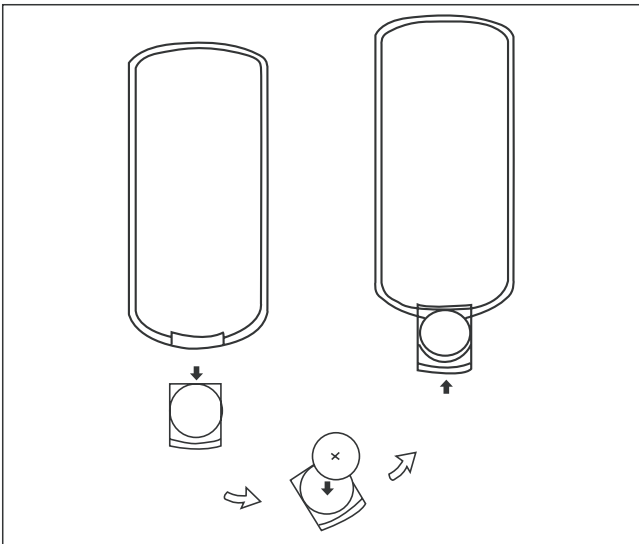

To use the remote control:

- 1 Open the battery compartment of the remote control, insert the battery, then close the compartment.
- 2 To use the remote control, point it at the remote sensor of the player. (Operate in the range of 16 feet (5 meters) and 60°.)

Tip

- Generally, batteries last for about one year. Replace the batteries if the remote control does not work.
- Remove the batteries if the remote control will not be used for an extended period of time.

Installing the battery pack

The battery must be charged and correctly installed before using it.

To attach the battery pack:

- 1 Turn the player off.
- 2 Unplug the AC adapter.
- 3 Turn the player upside down.
- 4 Insert the battery pack's catches into the corresponding holes in the player, then press the battery pack down until it clicks into place.

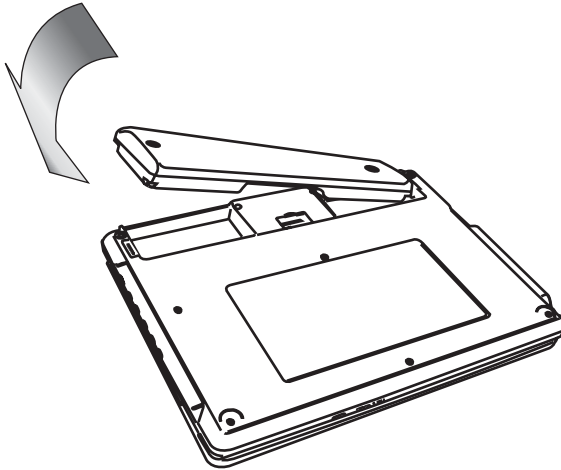

To charge the battery pack:

- 1 Turn the player off. The battery pack charges only when the power is turned OFF.
- 2 Attach the battery pack to the player.
- 3 Connect the AC adapter to the player.

When the battery is charging, the CHG indicator turns orange. When the charging is completed, the indicator turns off.

Note

- While the charging is in progress, do not disconnect the AC adapter until the CHG indicator turns off. The charging time of a battery pack is approximately 5.5 hours and depends on environmental conditions.
- The battery pack may get warm when you are charging it or operating the player. This is not a defect.
- The battery indicator appears on the screen when the power in the battery pack is running low.

To detach the battery pack:

- 1 Turn the player off.
- 2 Unplug the AC adapter.
- 3 Turn the player upside down.
- 4 Slide the battery lock switch to the open position, then remove the battery pack.

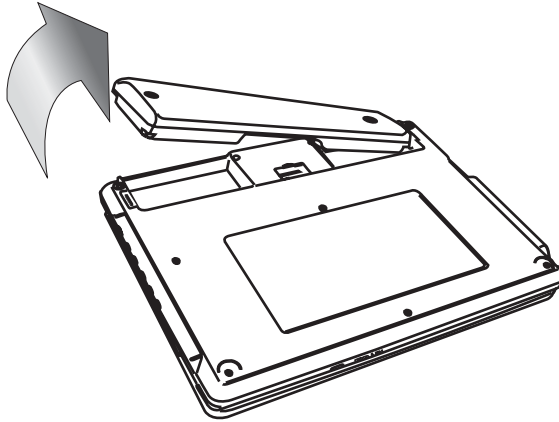
**Playback time**

After the battery pack is recharged, its continuous playing time is:

Operating status	Continuous playing time
Play DVD (display on)	About 5.5 hours
Play DVD (display off)	About 7 hours

Special considerations

The battery pack should only be used when the ambient temperature is between 41°F (5°C) and 95°F (35°C).

A newly purchased battery pack must be charged before use.

To assure the longest possible service life of the battery pack, charge it at (or below) indoor temperature.

Warnings

- Never dispose of the battery pack in fire or water.
- Do not use in high temperature or near heat sources.
- Do not let the positive and negative battery terminals come in contact with anything metal.
- Do not open the battery pack. Refer servicing to qualified service personnel only.

Connecting the AC adapter

To connect the AC adapter:

- 1 Plug the AC adapter into the **DC IN** jack on the left side of your player.

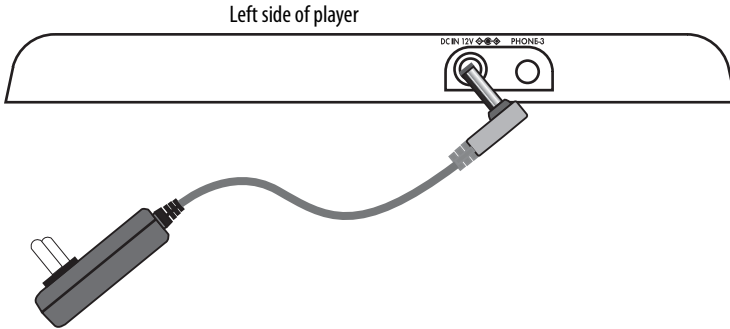

- 2 Plug the AC adapter plug into a 110 V power outlet.

Caution

Always turn off your player before you unplug the AC adapter, or you may damage your player.

Connecting headphones

To connect headphones:

- 1 Turn off your player.
- 2 Plug the headphones into the **PHONE 1** jack on the right side of your player.

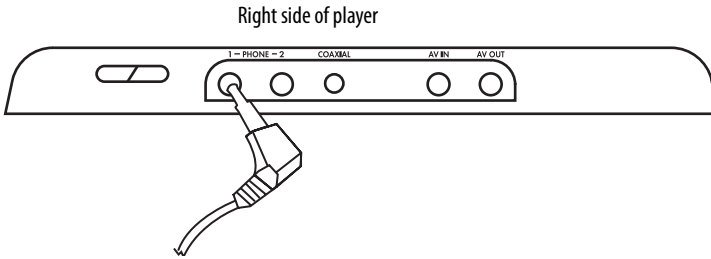

Caution

Always turn off your player before you connect or disconnect headphones, or you may damage your player.

Connecting a TV

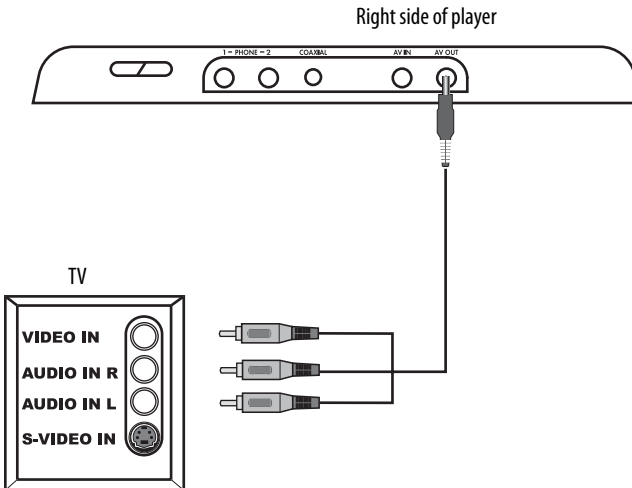

To connect a TV:

- 1 Plug the mini AV connector into the **AV OUT** jack on the right side of your player.
- 2 Plug the yellow connector into the **VIDEO IN** jack on the TV.

- 3 Plug the red connector into the **AUDIO IN R** jack on the TV.
- 4 Plug the white connector into the **AUDIO IN L** jack on the TV.

Connecting a TV and amplifier

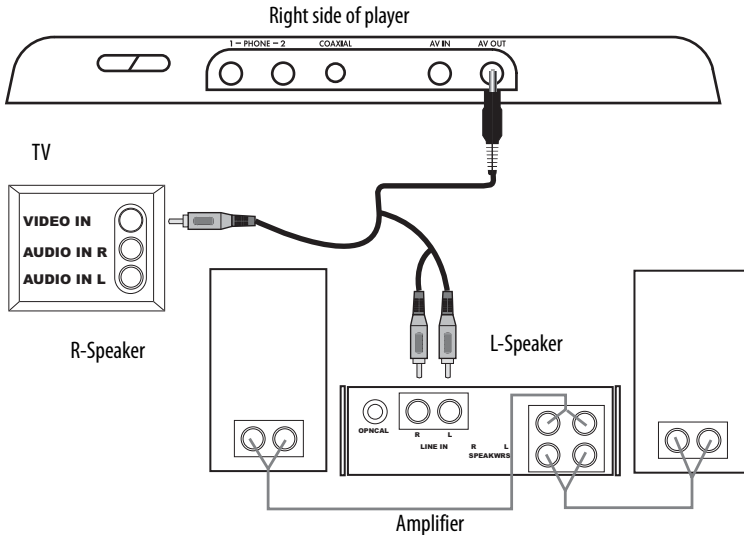

To connect a TV and amplifier:

- 1 Plug the mini AV connector into the **AV OUT** jack on the right side of your player.
- 2 Plug the yellow connector into the **VIDEO IN** jack on the TV.
- 3 Plug the red connector into the **AUDIO IN R** jack on the amplifier.
- 4 Plug the white connector into the **AUDIO IN L** jack on the amplifier.

Tip

If your amplifier has a coaxial digital input jack, you can connect your player to your amplifier using the **COAXIAL OUT** jack on your player.

Connecting an external audio/video device

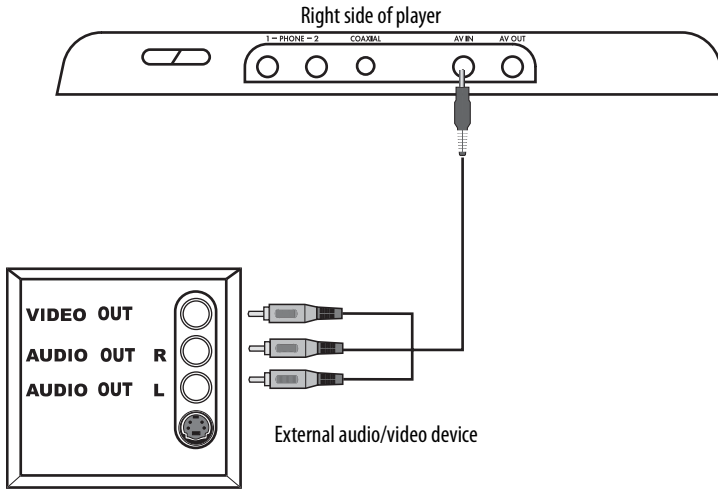

To connect an external audio/video device:

- 1 Plug the mini AV connector into the AV IN jack on the right side of your player.
- 2 Plug the yellow connector into the **VIDEO OUT** jack on the external audio/video device.
- 3 Plug the red connector into the **AUDIO OUT R** jack on the external audio/video device.
- 4 Plug the white connector into the **AUDIO OUT L** jack on the external audio/video device.

Using your player

Playable discs

Type	Disc logo	Content	Size	Playing time
DVD		Audio and video (motion pictures)	12 cm	About 2 hours (single side disc) About 4 hours (double-side disc)
			8 cm	About 80 minutes (single side disc) About 160 minutes (double-side disc)
CD		Audio	12 cm	About 74 minutes
			8 cm	About 20 minutes

Turning your player on and off

To turn your player on and off:

- 1 Open your player.
- 2 Press **POWER** on your player to turn on your player.
- 3 Press and hold **POWER** for two seconds to turn off your player.

Playing a disc

To play a disc:

- 1 Turn on your player.
- 2 Press **OPEN** to open the disc tray.



- 3 Place the disc, label side up, into the disc tray.
- 4 Press the disc tray cover down to close the tray.
- 5 Press **▶ / ||** to start disc playback.

Controlling disc playback

To control disc playback:

- To pause playback, press ► / ||. To resume playback, press ► / || again.
- To stop playback, press **STOP** twice.
- To fast-reverse or fast-forward, press ◀◀ or ▶▶. Each time you press one of these buttons the fast-reverse or fast-forward speed changes from 2x to 4x to 8x to 16x to 32x. Press ► / || to return to normal playback.
- To play a DVD in slow-motion, press **SLOW**. Each time you press the button the slow-motion speed changes from 1/2x to 1/4x to 1/8x to 1/16x. Press ► / || to return to normal playback.

Adjusting the picture

To adjust the picture:

- Press **SCREEN** on your player or the remote control one or more times.



- Press **SCREEN** once to access the brightness controls, then press ◀ or ▶ to adjust the brightness.
- Press **SCREEN** twice to access the contrast controls, then press ◀ or ▶ to adjust the contrast.
- Press **SCREEN** three times to access the color level controls, then press ◀ or ▶ to adjust the color level.
- Press **SCREEN** four times to access the aspect ratio controls, then press ◀ or ▶ to select **Normal 4:3** or **Wide 16:9**.

Adjusting the volume

To adjust the volume:

- Press + or – to increase or decrease the volume.

Using a DVD menu

Some DVDs have menus that let you select a title or chapter on the DVD.

To select a title or chapter from the DVD menu:

- 1 Put the DVD in the player.
- 2 Press ► / II. The root menu opens.

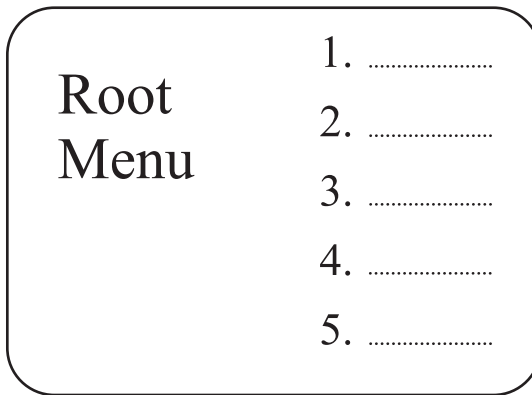

- 3 Press ►► or I◄◄ to skip to the next or previous page.
- 4 Select a title with either the number buttons or direction buttons.
- 5 Press ►►I to go to the next menu.

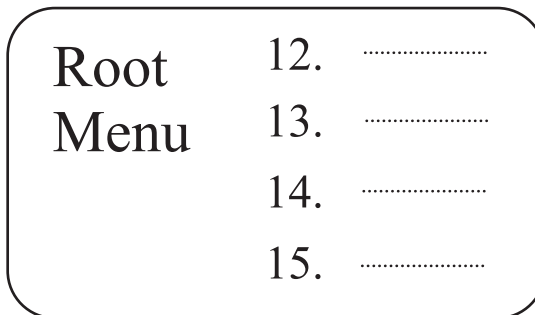

- 6 Press the number buttons to directly select a title or chapter, or press ▼ to select the title or chapter (for example, 13).

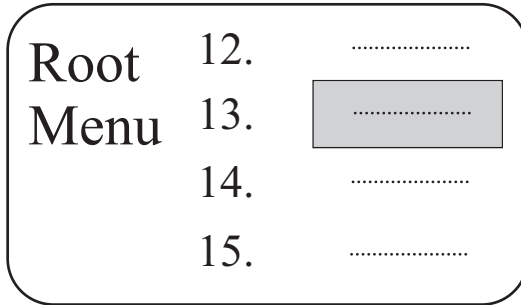

- 7 Press **OK** to start playing the chapter.
8 To return to the title menu, press **TOP MENU**.
Or, to return to the root menu, press **MENU**.

Selecting a DVD chapter or title or a CD track

To select a DVD chapter or title or CD track:

- 1 Put the disc in the player, the press ► / II.
- 2 After your player reads the disc, press the number buttons for the title, chapter, or track you want to play.

If the title, chapter, or track has a one-digit number (for example 8), press the number (8), then press **OK**. The following screen opens.

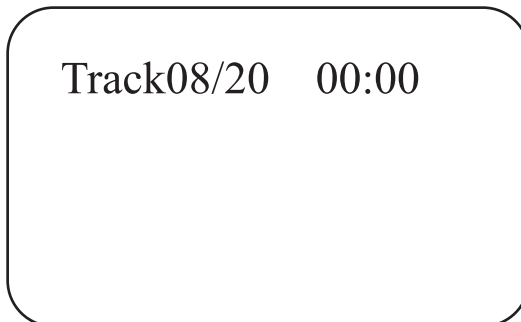



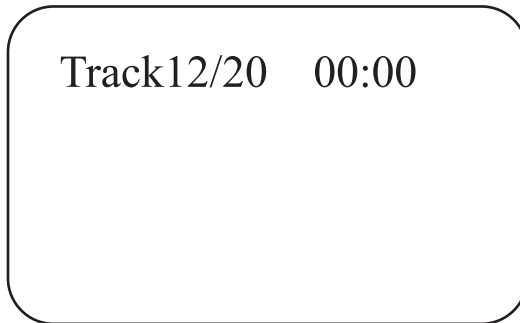

If the title, chapter, or track has a two-digit number (for example 12), press the number buttons (1 then 2), then press **OK**. The following screen opens.





Playing a disc repeatedly

You can play a DVD title, DVD chapter, CD track, or CD repeatedly.

To repeat a title or chapter on a DVD:



- 1 To repeat a chapter, press **REPEAT** until the screen shows  Chapter . Your player repeats the chapter.
- 2 To repeat a title, press **REPEAT** until the screen shows  Title . Your player repeats the title.
- 3 To repeat both the chapter and title, press **REPEAT** until the screen shows  ALL . Your player repeats the chapter and title.
- 4 To stop the repeat function, press **REPEAT** until  ALL disappears.

To repeat a track or an entire CD disc.

- 1 To repeat a track, press **REPEAT** until the screen shows  Track . Your player repeats the current track.
- 2 To repeat an entire disc, press **REPEAT** until the screen shows  ALL . Your player repeats the entire disc.
- 3 To stop the repeat function, press **REPEAT** until  ALL disappears.

Repeating a section of a disc

To repeat a section of a DVD or CD:

- 1 Press **A-B** where you want to start playback. The screen shows  A .
- 2 Play the disc until you reach the point where you want to start repeating from point A, then press **A-B** again. The screen shows  AB . Your player plays the section repeatedly.
- 3 To stop the repeat function, press **A-B** again until  AB disappears.

Selecting the DVD audio mode

If a DVD has more than one language recorded, you can select the audio language you want to hear.

To select the DVD audio mode:

- 1 While the DVD is playing, press **AUDIO TRACK**. The screen shows:



Audio 1/2:AC 3/2.1CH

- 2 Press **AUDIO TRACK** one or more times to select the language you want.

Selecting DVD subtitles

To select DVD subtitles:

- 1 Press **SUBTITLE** one or more times to select the subtitle language you want. The screen shows the selected language.



Subtitle 01/03:ENGLISH

- 2 To turn off subtitles, press **SUBTITLE** until the screen shows **Subtitle Off**.

Notes

- Subtitles cannot be turned off on some discs.
- Different languages may be available, depending on the disc.
- If subtitles are not available, the screen shows .

Searching on a disc

You can enter a time, title, or chapter number (for a DVD), or a specific track and time (for a CD) to start play from a specific point on a disc. Your player plays from the selected point.

To select a specific starting title and chapter on a DVD:

- 1 Press **SEARCH**. The screen shows:



Title 03/30 Chapter 01 /04

- 2 Press the arrow buttons to highlight a title number. The screen shows:



Title 03 /30 Chapter 01/04

- 3 Press a number button (for example, 6) to select a title number. The screen shows:



Title 06/30 Chapter 01/04

- 4 Press the arrow buttons to highlight the chapter number.
- 5 Press a number button to select the chapter number you want. After the settings are entered, your player starts playing the DVD from the selected title and chapter.

To select a specific starting time on a DVD:

- 1 Press **SEARCH** until the screen shows:

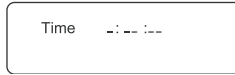

- 2 Press the number buttons to enter the hour, minute, and second for the amount of time you want to skip before your player starts playing. After the settings are entered, your player plays the disc from the selected point.

To select a specific starting track and time on a CD:

- 1 Press a number button to select the track you want to start playing from (for example, 6). The screen shows:

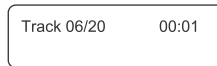

- 2 Press **SEARCH** to open the time search screen, then press **SEARCH** one or more times until the screen shows:



- 3 Press the number buttons to enter the amount of time in the track that you want to skip before your player starts playing (for example, 0138). The screen shows:

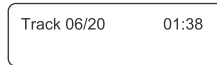

Your player plays the CD from the track and time you entered.

Note

You can search three ways on a CD:

- Press **SEARCH** once. The screen shows **DISC GOTO --:--**. You can enter the total time you want the CD to play.
- Press **SEARCH** twice. The screen shows **TRACK GOTO --:--**. You can enter the total time you want a track to play.
- Press **SEARCH** three times. The screen shows **TRACK --/20**. You can enter the track number you want to go to.

Enlarging the picture

You can enlarge (zoom) the picture displayed on the screen.

To enlarge the picture:

- 1 Press **ZOOM** during playback. The screen shows:



The picture is enlarged to twice its original size.

- 2 Press **ZOOM** repeatedly to select 2x, 3x, 4x, 1/2x, 1/3x, or 1/4x.
- 3 Press **◀**, **▲**, **▼**, or **▶** to move the enlarged picture.
- 4 To exit zoom mode, press **ZOOM** until the picture is normal size.

Setting parental controls

To turn parental controls on or off:

- 1 Press **SETUP**. The **SETUP MENU** opens.



- 2 Press ▼ to select **PASSWORD SETUP**, then press **OK**. The **Password Setup Page** opens.

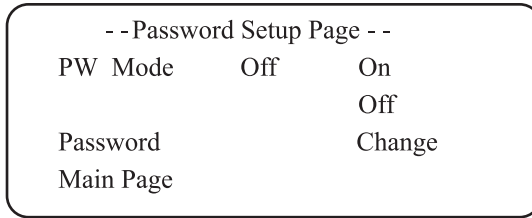

- 3 Press ►, then press ▼ to turn the **PW Mode Off** or **On**. If **PW Mode** is set to **On**, you are prompted to enter the password. The default password is **99999**.

To set parental controls:

- 1 Make sure that:
 - The disc tray is opened.
 - Or, the disc tray is empty.
 - Or, your player is in stop mode.
- 2 Press **SETUP**. The **SETUP MENU** opens.

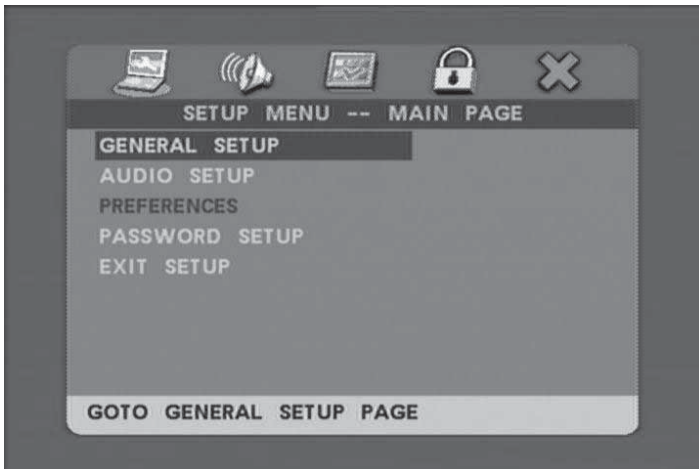

- 3 Press **▲** or **▼** to select **PREFERENCES**, then press **OK**. The **Preferences Page** opens.

Note

To select **PREFERENCES**, make sure that:

- The disc tray is open.
- Or, the disc tray is empty.
- Or, your player is in stop mode.

- 4 Press **▼** to select **Parental**. If this section is greyed, parental controls are turned on. You must first set **PW Mode** to **Off** in **PASSWORD SETUP**. The default password is **99999**.
- 5 Press **▶**, then press **▼** to select the rating you want to block. The rating you select and all higher ratings will be blocked.
- 6 Press **▶ / II**.

Using the SETUP MENU

Your player has a **SETUP MENU** that lets you select settings for your player. The following is an example of how to use the SETUP MENU to select the Reverb Mode.

To use the SETUP MENU:

- 1 Press **SETUP**. The **SETUP MENU** opens.

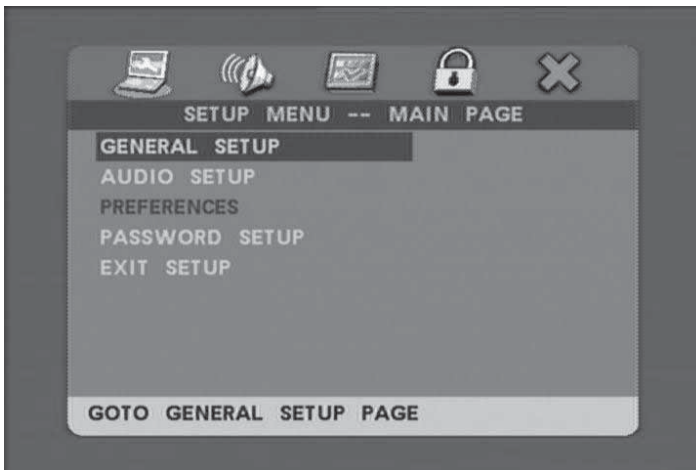

- 2 Press ▲ or ▼ to select **AUDIO SETUP**, then press **OK**. The **AUDIO SETUP PAGE** opens.



- 3 Press ▲ or ▼ to select an **3D PROCESSING**, then press **OK**.

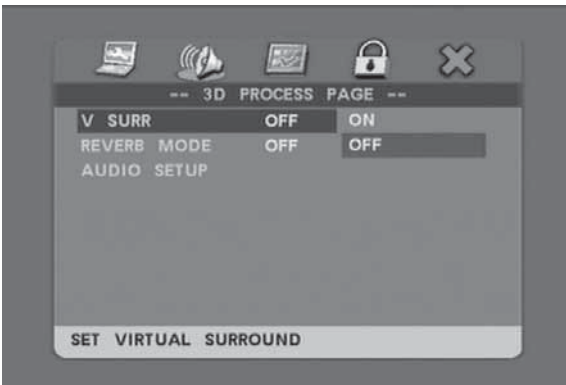

- 4 Press ▼ to select **REVERB MODE**.

- 5 Press **▶**, then press **▼** to select **LIVING ROOM**.

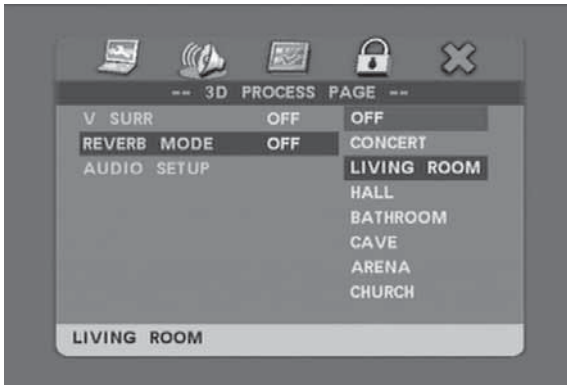

- 6 Press **OK**.

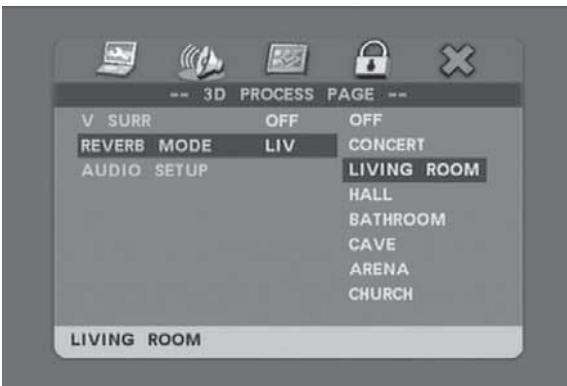

- 7 To exit, press **◀** to close the **REVERB MODE** screen.
- 8 Press **▼** to select **AUDIO SETUP**, then press **OK**.
- 9 Press **▼** to select **MAIN PAGE**, then press **OK**.
- 10 Press **▼** to select **EXIT SETUP**, then press **OK**.

OSD menus

General Setup Page

-- General Setup Page --		
TV Display	Wide	4:3 TV/PS 4:3 TV/LB 16:9 TV
OSD Lang	ENG	English French Spanish
Screen Saver	On	On Off
Last Memory	On	On Off
Main Page		

- **TV Display**—Lets you select the aspect ratio. You can select:
 - **TV/PS**—Select for normal TVs. Wide-screen images are shown on the screen with the left and right sides cut off.
 - **TV/LB**—Select for normal TVs. Wide-screen images are shown with black bars at the top and bottom of the image.
 - **Wide**—Select for wide-screen TVs.
- **OSD Lang**—Lets you select the language for the OSD. You can select **English**, **French**, or **Spanish**.
- **Screen Saver**—Lets you turn the screen saver on or off. If this option is turned on and your player is inactive for a few minutes, a screen saver appears to protect your TV from image burn-in.
- **Last Memory**—Lets you specify whether you want your player to start playback at the point on a disc where playback stopped and your player was turned off.

Audio Setup Page

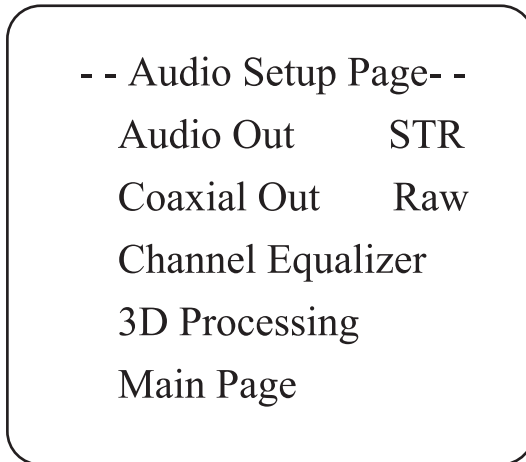

- **Audio Out**—Lets you select the audio output signal. You can select:
 - **Mixed Mono**—The output signal from a disc recorded in multi-channel format is sent to the right and left speakers.
 - **STR**—The output signal from a disc recorded in multi-channel format is converted to stereo.
- **Coaxial Out**—Lets you select the coaxial out signal type:
 - **MULTI CHANNEL**—Select this option if your player is connected to a digital amplifier through the digital jack. When you play a Dolby Digital disc or MPEG disc, the digital output is optional. The amplifier must have Dolby Digital and MPEG decoding.
 - **2 CHANNEL**—Select this option if your player is connected to a two-channel digital stereo amplifier. When you play a Dobby Digital disc or MPEG disc, the digital output is in PCM 2-channel format.
- **Channel Equalizer**—Lets you select an equalizer mode. You can select **None, Rock, Pop, Live, Dance, Techno, Classic,** or **Soft**. Press the arrow buttons to select a mode, then press ► / II.
- **3D Processing**—Lets you select how the audio is processed. You can select:
 - **V SURR**—Lets you turn virtual surround mode on or off.
 - **Reverb Mode**—Lets you select the reverb mode. You can select **Off, Concert, Living Room, Hall, Bathroom, Cave, Arena,** or **Church**.

Password Setup Page

You use this menu to set up a parental password and to change the password.

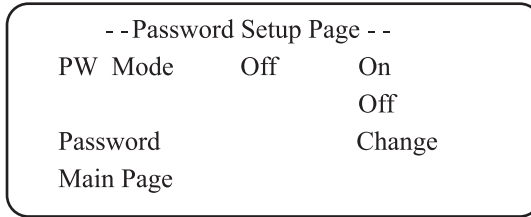

- **PW Mode**—Lets you turn the parental password feature on or off. When the parental password feature is turned on, the **Parental** option on the *Preference Page* is greyed.
- **Password**—Lets you change the parental password. The default password is **99999**. Enter the current password, enter the new password, then enter the new password again. Press **OK** to save your new password. If you forget your password, enter the default password.

Preference Page

-- Preference Page --		
TV Type	NTSC	PAL Multi NTSC
Audio	ENG	English French Chinese Japanese
Subtitle	ENG	English French Spanish Chinese Japanese Off
Disc Menu	ENG	English French Spanish Chinese Japanese
Parental	08	1 KID 2 G 3 PG 4 PG 13 5 PGR 6 R 7 NC17 8 ADULT
Default		Reset
Main Page		

- **TV Type**—Lets you select the TV's color system. You can select **PAL**, **Multi**, or **NTSC**.
- **Audio**—Lets you select the DVD audio language if the DVD has multiple audio languages.
- **Subtitle**—Lets you select the DVD subtitle language if the DVD has multiple subtitle languages.
- **Disc Menu**—Lets you select the DVD menu language if the DVD has multiple menu languages.

- **Parental**—Lets you set the rating level for DVDs. When you select a rating, that rating and all higher ratings are blocked. You need to enter your password to watch a DVD with a blocked rating. You can select **1 KID, 2 G, 3 PG, 4 PG 13, 5 PGR, 6 R, 7 NC17, or 8 ADULT.**
- **Default**—Lets you reset all settings to the factory default. This option does not reset the password.

Maintaining

Handling discs

- To keep a disc clean, do not touch the play side (non-label side) of the disc.
- Do not attach paper or tape to the disc.



- Keep the disc away from direct sunlight or heat sources.
- Store the disc in a disc case after playback.

Cleaning discs

- Before playback, wipe the disc outwards from the center with clean cloth.



Keep dust from the pickup lens by keeping the disc tray closed after use. If there is dust on the pickup lens, use a cleaning disc to clean them. Refer to the operating instructions of the cleaning disc you bought.

Troubleshooting

If you experience the following problems while using the player, this troubleshooting guide can help you.

No sound

- Make sure that the player is connected securely to the TV or amplifier.
- Make sure that the volume of the headphone is set to MIN when using headphones.
- Make sure that you operate the TV or amplifier correctly.
- Make sure that you have selected the DVD player position on the amplifier.

No image

- Make sure that the player is connected securely to the TV.
- Make sure that you operate the TV correctly.
- Make sure that you set the color system correctly.

Bad sound quality

- Make sure that the audio output mode is set correctly.
- Make sure that the audio connection between the player and amplifier is correct.

Disc cannot be played

- Make sure that there is a disc in the player.
- Make sure that the disc is placed on the disc tray correctly, with the label side up.
- Make sure that the disc is clean.
- If moisture has condensed in the player, remove the disc and leave the player on for about one hour.

Remote control does not work

- Remove barriers between the remote control and the player.
- Point the remote control at the remote control sensor of the player.
- Replace the batteries with new ones.

Image rolls and has no color

- The color system of the player does not match with that of TV. Select the correct TV TYPE until TV shows normal color.

Specifications

Specifications subject to change without notice.

Laser		Wavelength 650 nm
Video system		PAL/MULTI/NTSC
Frequency response		20 Hz ~ 20 KHz ±1dB
Signal/noise ratio		≥ 95dB
Audio distortion + noise		≤ -80 (1 KHz)
Channel separation		≥ 85dB
Dynamic range		≥ 85dB
Output	Audio out (analog audio)	Output level: 2V ±10% Load impedance: 10 K Ohms
	Audio out (digital audio)	Output level: 0.5Vp-p
	Video out	Output level: 1Vp-p ±20% Load impedance: 75 Ohm, imbalance, negative polarity
Power supply		DC 12V 2A
Allowable motion temperature		41 ~ 95°F (5 ~ 35°C)
Power consumption		≤ 20W
Dimensions		8.07 × 10.63 × 1.3 inches (205 × 270 × 33 mm)
Weight		About 2.64 lbs. (1.2 kg)
Region code		1

Legal notices

FCC Part 15

This device complies with Part 15 of the FCC Rules. Operation of this product is subject to the following two conditions: (1) this device may not cause harmful interference, and (2) this device must accept any interference received, including interference that may cause undesired operation.

This equipment has been tested and found to comply within the limits for a class B digital device, pursuant to Part 15 of the FCC Rules. These limits are designed to provide reasonable protection against harmful interference in a residential installation. This equipment generates, uses, and can radiate radio frequency energy and, if not installed and used in accordance with the instructions, may cause harmful interference to radio communications. However, there is no guarantee that interference will not occur in a particular installation. If this equipment does cause harmful interference to radio or television reception, which can be determined by turning the equipment off and on, the user is encouraged to try to correct the interference by one or more of the following measures:

- Reorient or relocate the receiving antenna.
- Increase the separation between the equipment and receiver.
- Connect the equipment into an outlet on a circuit different from that to which the receiver is connected.
- Consult the dealer or an experienced radio/TV technician for help.

FCC warning

Changes or modifications not expressly approved by the party responsible for compliance with the FCC Rules could void the user's authority to operate this equipment.

DHHS and FDA safety certification

This product is made and tested to meet safety standards of the FCC, requirements and compliance with safety performance of the U.S. Department of Health and Human Services, and also with FDA Radiation Performance Standards 21 CFR Subchapter J.

Canada ICES-003 statement

This Class B digital apparatus complies with Canadian ICES-003.

One-year limited warranty

Insignia Products ("Insignia") warrants to you, the original purchaser of this new product ("Product"), that the Product shall be free of defects in the original manufacture of the material or workmanship for a period of one (1) year from the date of your purchase of the Product ("Warranty Period"). This Product must be purchased from an authorized dealer of Insignia brand products and packaged with this warranty statement. This warranty does not cover refurbished Product. If you notify Insignia during the Warranty Period of a defect covered by this warranty that requires service, terms of this warranty apply.

How long does the coverage last?

The Warranty Period lasts for 1 year (365 days) from the date you purchased the Product. The purchase date is printed on the receipt you received with the Product.

What does this warranty cover?

During the Warranty Period, if the original manufacture of the material or workmanship of the Product is determined to be defective by an authorized Insignia repair center or store personnel, Insignia will (at its sole option): (1) repair the Product with new or rebuilt parts; or (2) replace the Product at no charge with new or rebuilt comparable products or parts. Products and parts replaced under this warranty become the property of Insignia and are not returned to you. If service of Products or parts are required after the Warranty Period expires, you must pay all labor and parts charges. This warranty lasts as long as you own your Insignia Product during the Warranty Period. Warranty coverage terminates if you sell or otherwise transfer the Product.

How to obtain warranty service?

If you purchased the Product at a retail store location, take your original receipt and the Product to the store you purchased it from. Make sure that you place the Product in its original packaging or packaging that provides the same amount of protection as the original packaging. If you purchased the Product from an online web site, mail your original receipt and the Product to the address listed on the web site. Make sure that you put the Product in its original packaging or packaging that provides the same amount of protection as the original packaging.

To obtain in-home warranty service for a television with a screen 30 inches or larger, call 1-888-BESTBUY. Call agents will diagnose and correct the issue over the phone or will have an Insignia-approved repair person dispatched to your home. Should the Insignia-approved repair person not correct the issue on the first call, an Insignia television (size and features to be determined by Insignia) will be loaned to you until your TV is repaired and returned, at no charge to you. This feature is only available to Insignia television consumers residing in the United States.

Where is the warranty valid?

This warranty is valid only to the original purchaser of the product in the United States, Canada, and Mexico.

What does the warranty not cover?

This warranty does not cover:

- Customer instruction
- Installation
- Set up adjustments
- Cosmetic damage
- Damage due to acts of God, such as lightning strikes
- Accident
- Misuse
- Abuse
- Negligence
- Commercial use
- Modification of any part of the Product, including the antenna
- Plasma display panel damaged by static (non-moving) images applied for lengthy periods (burn-in).

This warranty also does not cover:

- Damage due to incorrect operation or maintenance
- Connection to an incorrect voltage supply
- Attempted repair by anyone other than a facility authorized by Insignia to service the Product
- Products sold as is or with all faults
- Consumables, such as fuses or batteries
- Products where the factory applied serial number has been altered or removed

REPAIR REPLACEMENT AS PROVIDED UNDER THIS WARRANTY IS YOUR EXCLUSIVE REMEDY. INSIGNIA SHALL NOT BE LIABLE FOR ANY INCIDENTAL OR CONSEQUENTIAL DAMAGES FOR THE BREACH OF ANY EXPRESS OR IMPLIED WARRANTY ON THIS PRODUCT, INCLUDING, BUT NOT LIMITED TO, LOST DATA, LOSS OF USE OF YOUR PRODUCT, LOST BUSINESS OR LOST PROFITS. INSIGNIA PRODUCTS MAKES NO OTHER EXPRESS WARRANTIES WITH RESPECT TO THE PRODUCT, ALL EXPRESS AND IMPLIED WARRANTIES FOR THE PRODUCT, INCLUDING, BUT NOT LIMITED TO, ANY IMPLIED WARRANTIES OF AND CONDITIONS OF MERCHANTABILITY AND FITNESS FOR A PARTICULAR PURPOSE, ARE LIMITED IN DURATION TO THE WARRANTY PERIOD SET FORTH ABOVE AND NO WARRANTIES, WHETHER EXPRESS OR IMPLIED, WILL APPLY AFTER THE WARRANTY PERIOD. SOME STATES, PROVINCES AND JURISDICTIONS DO NOT ALLOW LIMITATIONS ON HOW LONG AN IMPLIED WARRANTY LASTS, SO THE ABOVE LIMITATION MAY NOT APPLY TO YOU. THIS WARRANTY GIVES YOU SPECIFIC LEGAL RIGHTS, AND YOU MAY ALSO HAVE OTHER RIGHTS, WHICH VARY FROM STATE TO STATE OR PROVINCE TO PROVINCE.

Contact Insignia:

For customer service please call 1-877-467-4289
www.insigniaproducts.com

Distributed by Best Buy Purchasing, LLC
7601 Penn Avenue South, Richfield, Minnesota, U.S.A. 55423-3645
© 2009 Best Buy Enterprise Services, Inc.

All rights reserved. INSIGNIA is a trademark of Best Buy Enterprise Services, Inc. Registered in some countries. All other products and brand names are trademarks of their respective owners.

INSIGNIA™

www.insigniaproducts.com (877) 467-4289

Distributed by Best Buy Purchasing, LLC
7601 Penn Avenue South, Richfield, MN USA 55423-3645
© 2009 Best Buy Enterprise Services, Inc.

All rights reserved. INSIGNIA is a trademark of Best Buy Enterprise Services, Inc.

Registered in some countries.

All other products and brand names are trademarks of their respective owners.

ENGLISH
09-0519